

SIMPLE AND UNIVERSAL CURRENT MODULATOR CIRCUIT FOR INDOOR MOBILE FREE-SPACE-OPTICAL COMMUNICATIONS TESTING

*Stanislav HEJDUK, Karel WITAS, Jan LATAL, Jan VITASEK, Jiri BOCHEZA,
Vladimir VASINEK*

Department of Telecommunications, Faculty of Electrical Engineering, VSB–Technical University of Ostrava,
17.listopadu 15/2172, 708 33 Ostrava-Poruba, Czech Republic

stanislav.hejduk@vsb.cz, karel.witas@vsb.cz, jan.latal@vsb.cz, jan.vitasek@vsb.cz, jiri.bocheza@vsb.cz,
vladimir.vasinek@vsb.cz

Abstract. *The use of LEDs for illumination and simultaneous communication becomes more and more interesting and it goes hand in hand with the increasing deployment of LEDs to peoples homes and industrial buildings. Modulation of this kind of light sources is difficult because of high voltage and of current demands. Since the LED configurations and the values of current and voltage are different, the universal modulator suggested by the research team of the Department of Telecommunications should be able to operate even under various circumstances. The objective of this paper is to present a design of a simple and universal current modulator for LED lighting modulation for the frequencies of around 1 MHz. The modulator should allow the initial testing of different types of High Power LEDs and different photodetector configurations and circuits in diffusively based Free-Space-Optical networks. Also, in the experimental part, the results obtained in the testing were compared with some different types of LED light sources.*

Keywords

Current modulator, free space optics, FSO, LED, lighting, mobile, network, visible light communication, VLC.

1. Introduction

LED diodes have been a significant part of everyday life for many years. Thanks to the falling prices and the exceptional lifetime of LEDs as well as to their increasing optical power it can be expected that in a few years they will replace fluorescent and incandescent light bulbs.

Although the idea of contemporary lighting and communication is not new [1], utilization of LEDs is still mostly of the experimental nature. Anyway, the future development of this technology is very promising especially due to their coverage parameters. Although the idea of contemporary lighting and communication isn't new [1], deployment is still mostly experimental nature. But future development of this technology is still very promising, especially for its coverage parameters. Compared with the radio networks, there is virtually no interference between the two systems since light cannot penetrate walls and opaque obstacles. There is also a possibility of precise defining of the covered area as well as of using more identical systems in one area even without them being divided by any walls and obstacles [2], [3].

For this type of a Free-Space-Optical (FSO) network or, at present, for a more frequently used the term a Visible Light Communication (VLC) system, the covered area will be considered as a diffusive network. That means that the covered area is evenly flooded with high optical power and the signal can also be detected after its reflection from walls and other obstacles. Thanks to this phenomenon, communication is possible even behind the Line-Of-Sight (LOS). And, of course, the speed limitations have to be considered with regard to their multipath signal propagation, which causes expansion of the transmitted pulses and, as for higher frequencies, even their multiplication. As a result, the photodetector will receive the same data several times in succession [4]. To limit this phenomenon, either the reflections have to be avoided, or some suitable modulation has to be used [5].

The main point is that indoor LED lighting needs much more energy than the point-to-point communication. Lights usually consist of larger blocks with higher voltage for lower demands on operational cur-

rent. In the end, there has to be some compromise made between the voltage and current suitable for the lighting applications. However, a new modulator with high power dissipation, high current capability and high output voltage has to be built at this stage. And due to higher parasitic capacity of these lights and their slower responses there is a loss of a valuable part of the modulation speed. At least, the response time of LEDs should not be a significant problem in the expected frequency range of around 1 MHz. The modulation fre-



Fig. 1: LED light with SMD LEDs matrix.

quency for white LEDs shown in Fig. 1 is limited to approximately 3 MHz due to the luminophore response. But this limit can be easily circumvented by using either the RGB LEDs (Fig. 2) instead of white LEDs, or a blue colour filter. This solution eliminates the long response component of luminophore and it theoretically increases the frequency response to 20 MHz [6].

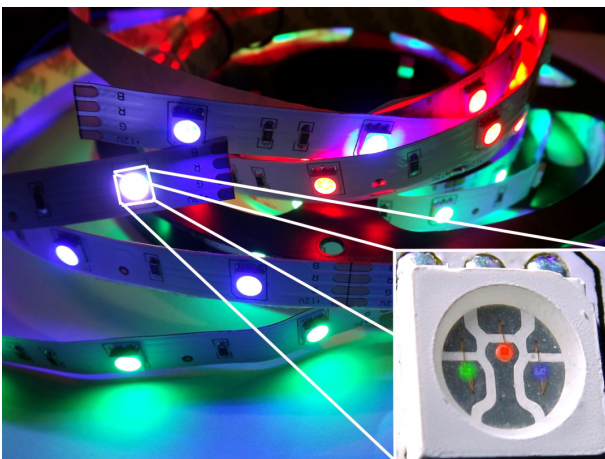

Fig. 2: LED strips with SMD5050 RGB LEDs.

Another speed limitation is connected to the light propagation and photo detection. Light from LEDs

disperses conically and the photodetected power can be calculated at any cross section as [2]:

$$P_{det.} = \frac{SA_R}{SA_T + \frac{\pi}{4}(\theta R)^2}, \quad (1)$$

where SA_R is the surface area of receiver, SA_T is the surface area of transmitter, θ is the divergence angle and R is the range in meters [2]. It means that the optical power will drop to a quarter every time the distance between transmitter and receiver is doubled. It can be seen in Fig. 3 what a big difference there is between the received optical powers for the distances from 0.1 to 1 meter.

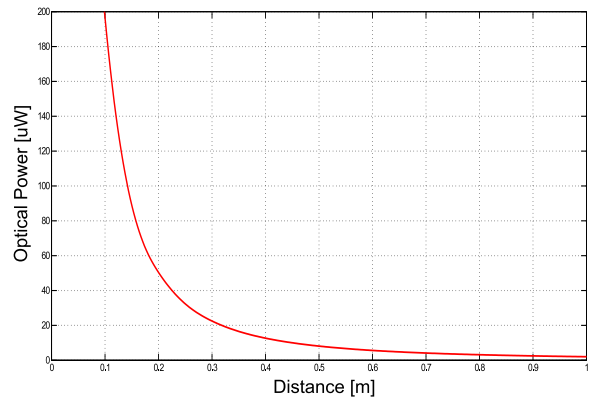

Fig. 3: Received power vs. transmitter distance.

The received power determines the required sensitivity of the photodetector. Higher sensitivity negatively affects the receiver speed [7]. The bandwidth of the photodetector has a high frequency cut-off given by:

$$B = \frac{1}{2\pi RC}, \quad (2)$$

where C is the parasitic capacitance of the photodetector and sensitivity is controlled by the value of the resistor R . The equivalent photodetector circuit is shown in Fig. 4.

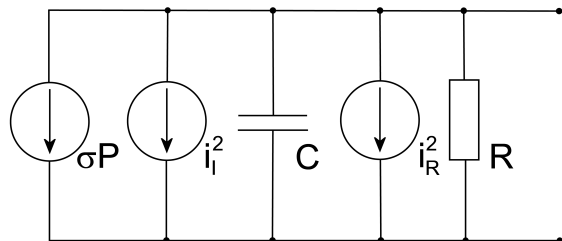

Fig. 4: Equivalent photodetector circuit.

Added to the signal, two noise contributions can also be found. The first one is the quantum noise associated

with the discrete nature of the total current (the sum of the signal current and the dark current) and its value is given by:

$$i_T^2 = 2e(I_{ph} + I_d)B, \quad (3)$$

where I_{ph} is the photodetected (signal) current, I_d is the dark current and B is the bandwidth.

The other one is the Johnson noise (or thermal noise) of resistance R :

$$i_R^2 = \frac{4kBT}{R}, \quad (4)$$

where k is the Boltzmann constant, T is the absolute temperature, B is the bandwidth and R is the value of the used load resistor.

With the background noise and all the above-mentioned assumptions the target frequencies are around 1 MHz, probably under or very close to the limit, and the usable bit rate is determined by the modulation used. Many modulation schemes have been tested under the Visible Light Communication (VLC) conditions so far. In addition to the basic OOK, the PWM (Pulse Width Modulation) [8] or the PPM (Pulse Position Modulation) [9], [10] can be mentioned as well. The main advantage of these modulations is the possibility of dimming the lights without any limitation of the transmitted power.

In the initial experiments worldwide the bitrates start at approximately $111 \text{ kbit}\cdot\text{s}^{-1}$ with the range of up to 1.5 meters [11]. On the other hand, in the laboratory conditions and with the appropriate modulation the commercial LEDs can reach the values of around $100 \text{ Mbit}\cdot\text{s}^{-1}$ [6], [12]. The increased interest in this type of communication has led to the introduction of the IEEE Standard for Local and Metropolitan Area Networks 802.15.7: Short-Range Wireless Optical Communication Using Visible Light [13], [15].

2. Requirements for the Modulator

Observability of communication is extremely important in contrast to the IR spectrum solutions. A person moving around in a room should not notice the difference between the normal and modulated lights. Due to the fact that communication is performed in the visible part of the spectrum, some special requirements have to be fulfilled. These requirements include the modulation scheme and the coding used for the data transmissions as well.

2.1. Modulation and Coding

The main requirement for the modulator is to keep a stable mean value of the transmitted signal. In that

case no power fluctuations will occur during the communication. For the simple On-Off-Keying modulation (OOK), the light is turned ON for logical 1 and OFF for logical 0. It means that the logical levels at the input are simply transferred to the light intensity at the output. Thus, the long sequence of zeros causes the lights to go out. That is why it is necessary to use a specific coding scheme with the OOK modulation in order to keep the mean value of the signal stable.

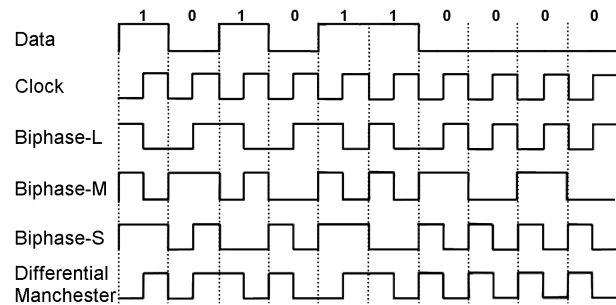

Fig. 5: Coding schemes suitable for the visible spectrum transmissions

All schemes mentioned in Fig. 5 keep the mean value stable for all possible data sequences. It makes the communication unobservable with the human eye. Of course, any modulation and configuration that keeps the mean value stable and that increases the bit rate to much more interesting values can be used e.g. MIMO (Multiple-Input Multiple-Output), [14].

2.2. Stability

Both the LEDs and the modulator have the tendency to change their parameters with the rising temperature and the frequency. The temperature problem is solved in the construction itself since the current source keeping the current values stable is used. But the frequency stability is much more complicated. The current gain of the transistors decreases with the increasing frequency. Thus, the integrated compensation is difficult to achieve, especially for different lights at the modulator output. As for the coding schemes shown in Fig. 5, the bounded range of frequencies is used. Then the modulator has to keep the light intensity stable for at least the used frequency range.

2.3. Energy Efficiency

In the above-mentioned application the power consumption of the used LEDs is higher. It is therefore necessary to minimize the system power consumption because the main advantage of the LEDs in terms of the energy consumption needs to be kept. The power dis-

sipation of the modulator will also be associated with the required size of a cooler.

3. Construction

The block diagram of the proposed modulator is shown in the Fig. 6.

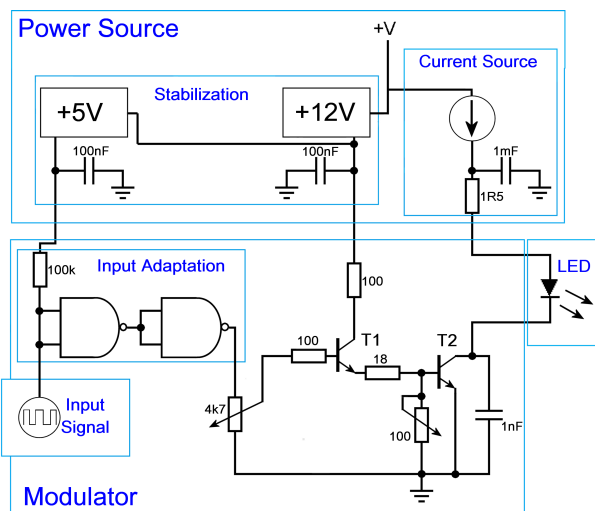

Fig. 6: Modulator block diagram.

The proposed modulator is described in the following part of the paper in accordance with the above-mentioned requirements and the block diagram.

3.1. Power Source

The energy is supplied by a single common power supply powering the LED and the modulator simultaneously. Thus, the whole modulator can be easily hidden inside any light without the need of any additional power source while maintaining the sufficiently high voltage level.

To ensure the stable output power, the LEDs are powered by an adjustable current source. The connection is extended by a capacitor keeping the current source under the load. This solution also conserves the useless energy when the light is OFF, and it releases it when the light is ON. It means that the light intensity is maintained despite the significant reduction of the LEDs activity time without increasing the current of the power source. This feature is also useful in the event of the input signal failure as the connected light cannot be overloaded with high current. However, this advantage may disappear if the LEDs lights have large additional internal resistors.

3.2. Control Circuit

The input circuit is adapted to the TTL logic to ensure stable reference for all performed measurements. And it can be easily replaced by a circuit with different parameters.

A key part of the modulator is a pair of bipolar transistors of high frequency and of high current capability. It is especially T2 that is very important and its type C2078 was chosen after several experiments. The operation points of both transistors are adjustable for maximum adaptability in the frequency and the current spectrum. This feature allows keeping both transistors right on the saturation limit. Otherwise, the transistors cannot open enough and due to this voltage drop limits the current flow.

Conversely, with too high saturation, the transistors are not able to close on time and the LEDs remain constantly lit. It is important for high frequencies to keep the switching times as short as possible, so the bases of both transistors are connected to the ground via resistors. The residual energy in the parasitic capacitances is immediately drained into the ground and the transistors can respond much faster.

The last part of the control circuit description deals with the LEDs parasitic capacity compensation. If the leading edge of the signal is too steep, some backswings in the transmitted signal can be experienced. It is caused by LEDs capacity and it can lead to significant signal degradation. Hence, the compensation capacitor is placed between the collector and the emitter of the T2 transistor. This capacitor effectively reduces the signal backswings, but, on the other hand, it, unfortunately, also limits the maximum operating frequency.

4. Measurement

The measurements were carried out on various types of LEDs used for illumination and on various ranges of frequencies. The first LED light was composed of a huge number of white SMD LEDs (shown in Fig. 1). Second light source was an RGB LED strip (Fig. 2). Thanks to the separation into different wavelengths, communication is possible on multiple wavelengths simultaneously. Then, the required communication wavelength can be easily chosen by an appropriate optical filter on the receiver side.

However, connection of the RGB LED strips was complemented by the series resistors of different values for the 12 V power source compensation. But these resistors are useful for the voltage control only. The last two lights are mainly designed for exterior lighting. The first outdoor fixture represents the streetlight with the total power of over 60 W. The other outdoor

light is the 20 W LED replacement of a halogen reflector. Both lights are shown in Fig. 7.



Fig. 7: Outdoor light sources.

A closer look to the outdoor light sources (Fig. 8) shows the construction of the streetlight and of the 20 W LED chip. Due to the limited voltage range of the current source there was only one LED block used for the measurement of the streetlight.

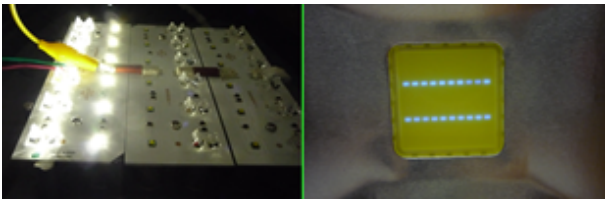

Fig. 8: Outdoor light internals (street light-left, 20 W chip-right).

4.1. Capacitive Load Compensation

Fig. 9 shows the oscilloscope view screen for the T2 Collector-Emitter voltage (lower part) and the Photodetector output voltage (upper part) of the LED strip for the input frequency of 220 kHz without a compensation capacitor.

When the transistor is turned on, the voltage between the collector and the emitter (U_{CE}) drops nearly to zero and the LEDs begin to emit light and illuminate the surface of the photodetector (THORLABS PDA100A-EC). In the opposite case, when the transistor is turned off, voltage U_{CE} rises and stops the current flow. If this case is looked at more precisely (Fig. 10), a large distortion in the waveform can be seen. At this moment both the delayed turn-off time with the distortion of the light intensity as well as the U_{CE} waveform can be seen. This distortion is problematic at higher frequencies because it causes some visible changes in the light intensity. The compensation

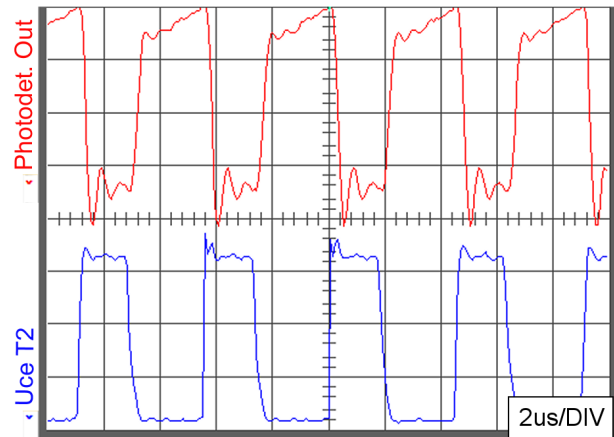

Fig. 9: Signal view on oscilloscope view screen.

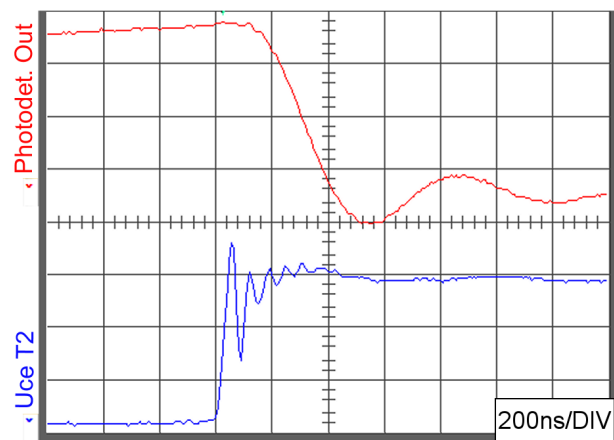

Fig. 10: Transistor turn OFF process without compensation.

for communication via the visible spectrum is necessary even at the cost of longer response times between switching off and on. In Fig. 11 there is a waveform with 3 nF compensation capacitor.

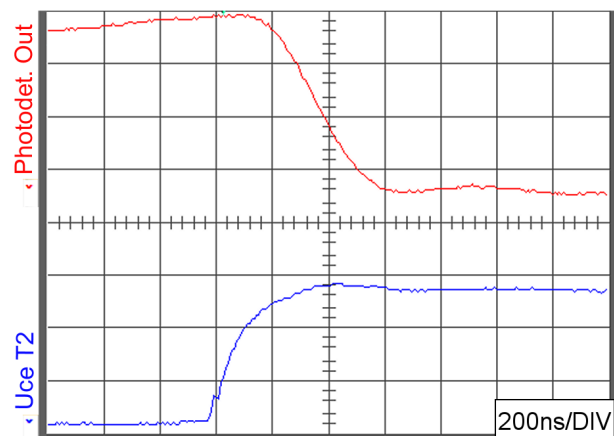

Fig. 11: Transistor turn OFF process with 3 nF compensation.

Fig. 11 shows the LED light mentioned in Fig. 1 (without serial resistances in its connection). It can be

noticed that the distortions were much higher than in Fig. 9.

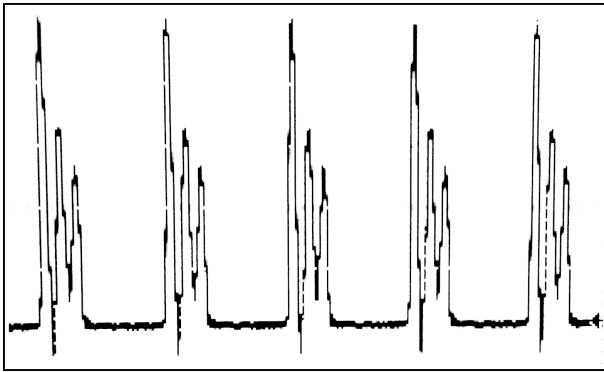

Fig. 12: U_{CE} waveform on T2 without serial resistors and compensation.

In this case the distortion of the transmitted signal is too high to ensure its clear detection. In the worst case the detected signal could be fragmented into several parts.

4.2. Frequency Response

Two parameters, the received signal amplitude at the photodetector output and the light intensity of the emitted light, were monitored during the frequency response measurement. The used photodetector has the bandwidth limitation at 2.4 MHz. Thus, the signal amplitude above this frequency is used for the detection of the optical signal presence in the emitted light only. Fig. 13 shows the results of LED light on the operating frequencies from 100 kHz to 3 MHz. In this case,

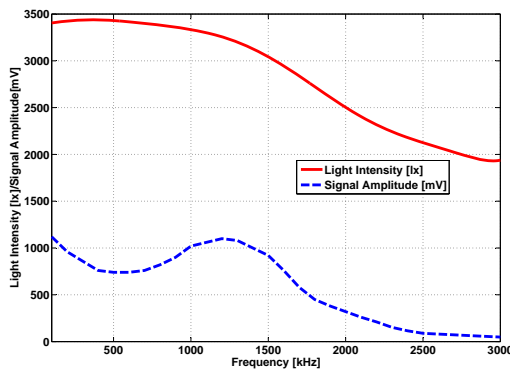

Fig. 13: LED light frequency characteristics ($I = 360 \text{ mA}$, $+V = 40 \text{ V}$).

light intensity is stable at frequencies of up to 1 MHz. Then the light intensity starts to fade slowly. This is caused by the decreasing gain of the modulator. The communication signal is detectable even at frequencies

of around 3 MHz. With regard to the fact that the operating point is adjustable, the light intensity can even be kept in higher frequencies. This case is shown in Fig. 14 where two different operating points are set for the RGB LED strip. Communication can then con-

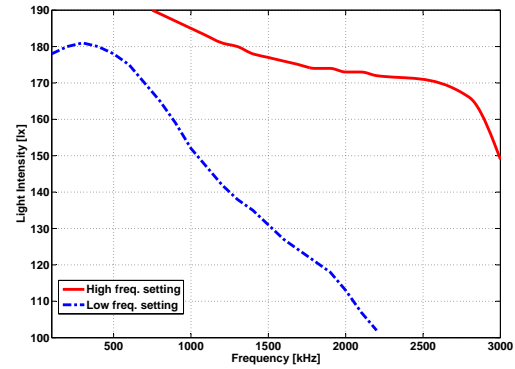

Fig. 14: LED strip frequency characteristics for two different setting.

tinue without the light fading even at frequencies of up to 2.8 MHz. However, this high frequency setting does not work at lower frequencies due to the higher saturation and the longer response times. Thus, for the practical use the working frequencies have to be considered and the operating point of the modulator has to be set. For the Differential Manchester, only a small part of the measured frequency spectrum is then needed. The above-mentioned lights were constructed from small LEDs. But at present much more powerful LEDs in streetlight have to be taken into account. As

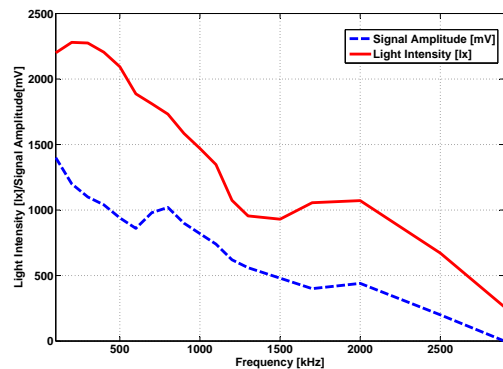

Fig. 15: Streetlight frequency characteristics

we can see in Fig. 15 the values are much more uneven in comparison with the low power LEDs (Fig. 13 and Fig. 14). To maintain the stable light intensity is much more difficult event with manual adjusting of the operating point. On the other hand, during the test the communication part of the signal worked even under these adverse circumstances at frequencies of around

2 MHz. Due to the loss of the light intensity and the distortion of the output signal the system limit at frequencies of around 1 MHz can be considered.

The results for the halogen lamp replacement with a 20 W LED chip are in Fig. 16. The light intensity for frequencies of up to 1.6 MHz is much more uniform compared to the streetlight. The significant increase in the light intensity at 2 MHz was very problematic to compensate and it could even be observable with the naked eye during the measurement. The usable communication frequencies are therefore limited to 1.6 MHz.

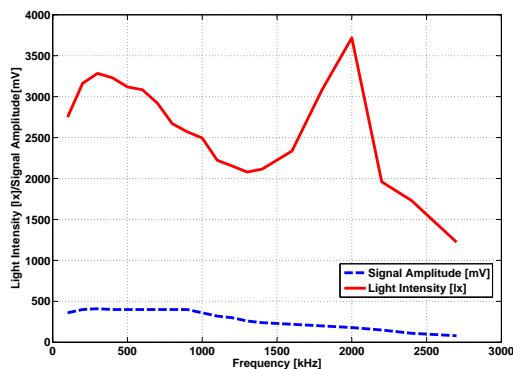

Fig. 16: 20 W LED chip frequency characteristics.

5. Conclusion

With respect to the measured values it can be confirmed that the applicable frequency decreases simultaneously with the increasing surface area of the used LEDs. The uniformity of the light intensity is also much better for smaller LEDs solutions.

Despite the communication functionality of the power LEDs at higher frequencies, the fluctuations of the light intensity can sometimes be observable and they therefore limit the usable frequency range. According to IEEE 802.15.7, the defined frequency for PHY1 [13], [15], (high power applications with OOK) is only 200 kHz, which is far below the achieved values.

The frequency limit for this modulator solution is 3 MHz, which is within the intended range. The main objectives of the construction were its low cost as well as its powering by a single power source. To properly evaluate this phenomenon as a whole, the parameters of the used LED lights as well as of the used photodetector have to be taken into account. The main limitation of this modulator is its output voltage, which is limited to 40 V, and it therefore does not allow connecting all the 3 blocks of the used streetlight.

If we take a look at some high-power LEDs datasheets, their rise-time and fall-time values can sometimes be seen. The normal values are around 100 nanoseconds and thus the current modulator is not limited by the LEDs response times.

The main problem with the mobile Free-Space-Optical communication is caused by the used photodetector. Because of the necessary sensitivity the photodetector bandwidth is limited. This phenomenon could also be observed during the measurement when the values measured by the photodetector declined despite the obvious presence of the output signal.

Acknowledgment

This article was created with the active support of the Ministry of Education of the Czech Republic within the projects no. SP2013/88, SP2013/69, SP2014/77 and SP2014/147 of VSB–Technical University of Ostrava. This article was supported by the projects no. VG20102015053 and TA03020439. The research has been partially supported by the project no. CZ.1.07/2.3.00/20.0217 "The development of Excellence of the Telecommunication Research Team in Relation to International Cooperation" within the frame of the operation programme "Education for Competitiveness" financed by the Structural Funds and from the state budget of the Czech Republic.

References

- [1] LITTLE, T. D. C., P. DIB, K. SHAH, N. BARRAFORD and B. GALLAGHER. Using LED Lighting for Ubiquitous Indoor Wireless Networking. In: *4th IEEE International Conference on Wireless & Mobile Computing, Networking and Communication: WiMob 2008*. Avignon: IEEE, 2008, pp. 373–378. ISBN 978-0-7695-3393-3. DOI: 10.1109/WiMob.2008.57.
- [2] AKELLA, J., Ch. LIU, D. PARTYKA, M. YUKSEL, S. KALYANARAMAN and Partha DUTTA. Building Blocks for Mobile Free-Space-Optical Networks. In: *Second IFIP International Conference on Wireless and Optical Communications Networks: WOCN 2005*. Dubai: IEEE, 2005, pp. 164–168. ISBN 0-7803-9019-9. DOI: 10.1109/WOCN.2005.1436011.
- [3] DAYONG, Z., P. G. LOPRESTI and H. H. REFAI. Enlargement of Beam Coverage in FSO Mobile Network. *Journal of Lightwave Technology*. 2011, vol. 29, iss. 10, pp. 1583–1589. ISSN 0733-8724. DOI: 10.1109/JLT.2011.2134069.

- [4] MIHAESCU, A. and P. BESNARD. Indoor wireless optical communications. In: *8th International Conference on Communications (COMM), 2010*. Bucharest: IEEE, 2010, pp. 359–362. ISBN 978-1-4244-6360-2. DOI: 10.1109/ICCOMM.2010.5509017.
- [5] LUCACIU, R., A. MIHAESCU and C. VLADANU. Dynamic OCDMA coding for indoor wireless optical communications. In: *8th International Conference on Communications (COMM), 2010*. Bucharest: IEEE, 2010, pp. 347–350. ISBN 978-1-4244-6360-2. DOI: 10.1109/ICCOMM.2010.5509009.
- [6] GRUBOR, J., S. Ch. J. LEE, K.-D. LANGER, T. KOONEN and J. W. WALEWSKI. Wireless High-Speed Data Transmission with Phosphorescent White-Light LEDs. In: *Optical Communication, 2007 33rd European Conference and exhibition of: Post-Deadline Papers*. Berlin: IEEE, 2007, pp. 1–2. ISBN 978-3-8007-3059-9.
- [7] DONATI, S. *Photodetectors: Devices, Circuits, and Applications*. Upper Saddle River, NJ: Prentice Hall, 2000. ISBN 01-302-0337-8.
- [8] MIRVAKILI, A. and V. J. KOOMSON. High efficiency LED driver design for concurrent data transmission and PWM dimming control for indoor visible light communication. In: *Photonics Society Summer Topical Meeting Series, 2012 IEEE*. Seattle: IEEE, 2012, pp. 132–133. ISBN 978-1-4577-1526-6. DOI: 10.1109/PHOSST.2012.6280761.
- [9] CHOI, S. New Type of White-light LED Lighting for Illumination and Optical Wireless Communication under Obstacles. *Journal of the Optical Society of Korea*. 2012, vol. 16, iss. 3, pp. 203–209. ISSN 1226-4776. DOI: 10.3807/JOSK.2012.16.3.203.
- [10] XIAOXUE, M., Kyujin LEE and Kyesan LEE. Appropriate modulation scheme for visible light communication systems considering illumination. *Electronics Letters*. 2012, vol. 48, iss. 18, pp. 1137–1139. ISSN 0013-5194. DOI: 10.1049/el.2012.2195.
- [11] WANG, J., N. ZOU, D. WANG, K. IRIE, Z. IHA and Y. NAMIHARA. Experimental study on visible light communication based on LED. *The Journal of China Universities of Posts and Telecommunications*. 2012, vol. 19, supp. 2, pp. 197–200. ISSN 1005-8885. DOI: 10.1016/S1005-8885(11)60422-6.
- [12] PISEK, E., S. RAJAGOPAL and S. ABUSURRA. Gigabit rate mobile connectivity through visible light communication. In: *IEEE International Conference on Communications (ICC), 2012*. Ottawa: IEEE, 2012, pp. 3122–3127. ISBN 978-1-4577-2052-9, ISSN 1550-3607. DOI: 10.1109/ICC.2012.6363739.
- [13] ITU-I. *802.15.7.: Short-Range Wireless Optical Communication Using Visible Light* [online]. 2011. Available at: <http://www.ieee802.org/15/pub/TG7.html>.
- [14] MESLEH, R., R. MEHMOOD, H. ELGALA and H. HAAS. Indoor MIMO Optical Wireless Communication Using Spatial Modulation. In: *IEEE International Conference on Communications (ICC), 2010*. Cape Town: IEEE, 2010, pp. 1–5. ISBN 978-1-4244-6402-9, ISSN 1550-3607. DOI: 10.1109/ICC.2010.5502062.
- [15] ROBERTS, Richard D., Sridhar RAJAGOPAL and Sang-Kyu LIM. IEEE 802.15.7 physical layer summary. In: *GLOBECOM Workshops (GC Wkshps)*. Houston: IEEE, 2011, pp.772–776. ISBN 978-1-4673-0039-1. DOI: 10.1109/GLOCOMW.2011.6162558.

About Authors

Stanislav HEJDUK was born in Ostrava, Czech Republic, in November 1985. He received his M.Sc. degree in telecommunication technologies from VSB–Technical University of Ostrava, in 2010. After that he became a postgradual student of Communication Technologies at the VSB–Technical University of Ostrava, department of Telecommunication. His research focuses on transmitters for Mobile Free-Space Optical Communications.

Karel WITAS was born in Frydek-Mistek, 1975. He received his M.Sc. degree in electrical engineering from VSB–Technical University of Ostrava, in 1998. He began his career in 2000 working on special test equipment for semiconductor devices evaluation at the SCG Czech Design Center, ON Semiconductor, Roznov p. Radhostem. In 2009, he joined the team of the Dept. of Telecommunication, VSB–Technical University of Ostrava, developing optical fiber sensors. His research interests include sub-nanoseconds pulse generators, noise free amplifiers and ultra-low current converters.

Jan LATAL was born in Prostejov. In 2006 he was awarded his B.Sc. degree at VSB–Technical University of Ostrava, Faculty of Electrical Engineering and Computer Science, Department of Electronics and Telecommunications. He was awarded his M.Sc.

degree at VSB–Technical University of Ostrava, Faculty of Electrical Engineering and Computer Science, Department of Telecommunications in 2008. He is currently Ph.D. student, and he works in the field of Wireless Optical Communications, Optical Communications and Distributed Temperature Sensing Systems. He is a member of SPIE and IEEE.

Jan VITASEK was born in Opava. In 2009 he finished M.Sc. study at Brno University of Technology, Faculty of Electrical Engineering and Communication. In present time he is Ph.D. student at Department of Telecommunications, VSB–Technical University of Ostrava. His interests are Free Space Optics and indoor Free Space Optics networks. He is a member of SPIE.

Jiri BOCHEZA was born in Zlin, Czech Republic, 27 July 1985. He received his M.Sc. degree in telecommunication technologies from VSB–Technical University of Ostrava, in 2010. After that he became a postgradual student of Communication Technologies at the VSB-TU Ostrava, Department of Telecommunications. His research focuses on optoelectronics and application of conductive polymers in fiber optics systems. In 2012 he started working at MESIT

with specialization on microprocessors and FPGAs programming.

Vladimir VASINEK was born in Ostrava. In 1980 - he graduated at the Science Faculty of the Palacky University, branch - Physics with specialization in Optoelectronics, RNDr. he obtained at the Science Faculty of the Palacky University at branch Applied Electronics, scientific degree Ph.D. he obtained in the year 1989 at branch Quantum Electronics and Optics, he became an associate professor in 1994 at branch Applied Physics, he is a professor of Electronics and Communication Science since 2007 and he works at this branch at the Department of Telecommunications of the Faculty of Electrical Engineering and Computer Science. His research work is dedicated to optical communications, optical fibers, optoelectronics, optical measurements, optical networks projecting, fiber optic sensors, MW access networks. He is a member of many societies – OSA, SPIE, EOS, IMEKO, Czech Photonics Society, he is a chairman of Ph.D. board at the VSB–Technical University of Ostrava, and he was a member of many boards for habilitation and professor appointment.